



**AIRFACE**

**RGB**

## FEATURES

### 特點 / 特点

#### ENGLISH

- Perforated design for unobstructed ventilation
- Innovative quick slide dust filter
- Integrated RGB system with 5V ARGB motherboard synchronization
- Support for E-ATX motherboard
- Up to 330mm graphics cards
- Up to five fans and 190mm CPU cooler

#### RUSSIAN

- Перфорированная конструкция для беспрепятственной вентиляции
- Инновационный быстросъемный пылевой фильтр
- Встроенная RGB синхронизация с материнской платой через 5V ARGB
- Поддержка материнской платы E-ATX
- Вмещает видеокарту длиной до 330 мм
- Вмещает до пяти вентиляторов и 190-мм процессорный кулер

#### SPANISH

- Diseño perforado para una ventilación sin obstáculos
- Innovador filtro de polvo de deslizamiento rápido
- Sistema RGB integrado con sincronización de placa base ARGB de 5V
- Soporte para placa base E-ATX
- Tarjetas gráficas de hasta 330 mm
- Hasta cinco ventiladores y un cooler de CPU de 190 mm

#### BRAZILIAN PORTUGUESE

- Desing perfurado para ventilação sem obstruções
- Inovador filtro de pó de deslizamento rápido
- Sistema RGB integrado com sincronização da placa-mãe ARGB de 5V
- Suporte para a placa-mãe E-ATX
- Placas gráficas de até 330mm
- Até cinco ventiladores e um CPU Cooler de 190mm

#### GERMAN

- Perforiertes Design für ungehinderte Luftzirkulation
- Innovativer Staubfilter mit Schnellverschluss
- Integriertes RGB-System mit 5V-ARGB-Synchronisierung der Hauptplatine
- Unterstützung für E-ATX-Motherboards
- Grafikkarten bis zu 330 mm
- Bis zu fünf Lüfter und 190-mm-CPU-Kühler

#### KOREAN

- 방해받지 않는 환기를 위한 천공 설계
- 혁신적인 퀵 슬라이드 먼지 필터
- 5V ARGB 마더보드 동기화 기능이 있는 통합 RGB 시스템
- E-ATX 마더보드 지원
- 최대 330mm 그래픽 카드 장착 가능
- 최대 5개의 팬 및 190mm CPU 쿨러 장착 가능

#### 日本語

- メッシュデザインで放熱性に優れています
- 革新的なスライド防塵フィルター
- 統合したRGBシステムによって5V ARGBマザーボードのRGBに同期可能
- E-ATXマザーボードもサポート
- 最大330mmのグラフィックカードに対応できます
- 最大5つのファンと190mmのCPUクーラーを搭載可能

#### 中文

- 网孔面板带来畅通无阻散热气流
- 侧拉式快拆防尘滤网
- 整合式RGB系统支援5V ARGB主机板灯效同步功能
- 支援E-ATX 主机板
- 最高支援330mm 显卡
- 最高支援5个风扇和190mm CPU散热器

## ASSEMBLY DRAWING

### 爆炸圖 / 爆炸图

- A** Airflow front panel  
金屬網孔前飾板 / 金属网孔前饰板
- B** Quick slide dust filter  
側拉式快拆防塵濾網 / 侧拉式快拆防尘滤网
- C** 2 x 120mm / 2 x 140mm fans for front panel  
(140mm ARGB fans x 2 pre-installed)  
前板支援2 x 120mm / 2 x 140mm風扇  
(預裝140mm ARGB風扇x 2)  
前板支援2 x 120mm / 2 x 140mm 風扇  
(預裝140mm ARGB風扇x 2)
- D** Air filter for bottom panel  
底部防塵網 / 底部防尘网
- E** Tempered glass side panel  
玻璃左側板 / 玻璃左侧板
- F** Vertical slot covers  
垂直擴充插槽 / 垂直扩充插槽
- G** 1 x 120mm / 1 x 140mm fan for rear panel  
(120mm ARGB fan x 1 pre-installed)  
背板支援1 x 120mm / 1 x 140mm 風扇  
(預裝120mm ARGB風扇x 1)  
背板支援1 x 120mm / 1 x 140mm 風扇  
(預裝120mm ARGB風扇x 1)
- H** Air filter for top panel  
上蓋防塵網 / 上盖防尘网
- I** 2 x 120mm / 2 x 140mm fans for top panel  
上蓋支援2 x 120mm / 2 x 140mm 風扇  
上蓋支援2 x 120mm / 2 x 140mm 風扇
- J** 2.5"SSD tray  
2.5" SSD托盤 / 2.5" SSD托盘
- K** Right side panel  
右側板 / 右侧板
- L** 3.5"HDD cage  
3.5" HDD 硬碟槽 / 3.5" HDD硬盘槽

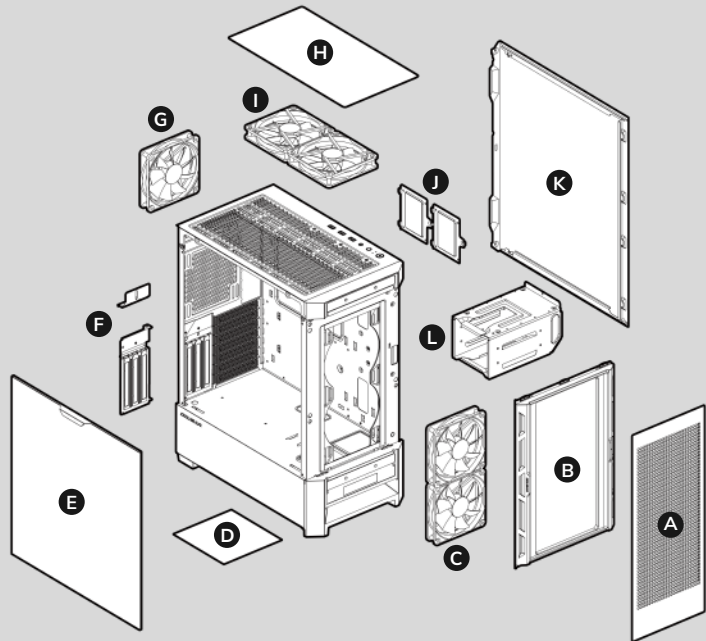

# SPECIFICATIONS

## 規格 / 规格







Product Name 產品名稱 / 产品名称	Airface RGB
Case Form Factor 機箱規格 / 机箱规格	Mid Tower / 中塔機箱 / 中塔机箱
Motherboard Type 主板類型 / 主板类型	Mini ITX / Micro ATX / ATX / CEB / *E-ATX
Dimension 尺寸(寬 x 高 x 深) / 尺寸(宽x高x深)	230(W) x 491(H) x 386(D) (mm) / 9.1(W) x 19.3(H) x 15.2(D) (in)
I/O Panel I/O 接口	USB 3.0 x 2, USB 2.0 x 1, 4 Pole Headset Audio Jack x1, RGB Button
3.5" Drive Bay 3.5" 硬碟槽 / 3.5" 硬盘槽	2
2.5" Drive Bay 2.5" 硬碟槽 / 2.5" 硬盘槽	2 (2 SSD trays included) / 2 (內附2個SSD硬碟托盤) / 2 (內附2個SSD硬盘架)
Expansion Slots 擴充插槽 / 扩充插槽	7+3
Cooling Fan Support 散熱風扇規格 / 散热风扇规格	Front / 前板 : 120mm x 2 / 140mm x 2 (140mm ARGB fan x 2 pre-installed) (預裝140mm ARGB風扇x 2) / (預裝140mm ARGB风扇x 2)
	Top / 上蓋 / 上盖 : 120mm x 2 / 140mm x 2
	Rear / 背板 : 120mm x 1 / 140mm x 1 (120mm ARGB fan x 1 pre-installed) (預裝120mm ARGB風扇 x 1) / (預裝120mm ARGB风扇 x 1)
Maximum Number of Fans 最高風扇安裝數量 最高风扇安装数量	5

Water Cooling Radiator Support 水冷排規格 / 水冷排规格	Front / 前板 : *280mm / 240mm / 140mm / 120mm
	Top / 上蓋 / 上盖 : *280mm / 240mm / 140mm / 120mm
	Rear / 背板 : 140mm / 120mm
Transparent Left Panel 透明左側蓋 / 透明左侧盖	4mm Tempered Glass / 4mm鋼化玻璃 / 4mm 钢化玻璃
Onboard Lighting System 支援主板RGB燈效同步軟體 支援主板RGB同步软件	Yes
RGB Sync with M/B 燈效控制板 / 灯效控制板	Yes
ARGB LED strip ARGB LED燈條 ARGB LED灯条	Yes
Max. Graphics Card Length 顯卡最大長度 显卡最大长度	330(mm) / 13(in)
Max. CPU Cooler Height CPU 風扇最大高度 CPU 风扇最大高度	190(mm) / 7.5(in)
Max. PSU Length 電源供應器最大長度 电源供应器最大长度	160(mm) / 6.3(in)

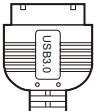
- E-ATX up to 277mm wide. / E-ATX 主板最高可支援寬度為277mm / E-ATX 主板最高可支援寬度為 277 mm。
- Please choose either front or top to install a 280mm radiator.  
280 mm 水冷排請擇一安裝於前板或上蓋 / 280 mm 水冷排請擇一安裝於前板上蓋。
- Max. length of RTX 3090 graphic card is 325mm. / RTX 3090 顯卡長度最大為325mm / RTX 3090 显卡长度最大為 325 mm。













## INSTALLING THE I / O CONNECTORS

I/O 線材接頭 / I/O 线材接头

USB 3.0	USB 2.0	HD AUDIO HD音效線 HD音效线	POWER SW 電源開關線 电源开关线	POWER LED 電源 LED 燈線 电源 LED 灯线	H.D.D LED H.D.D LED 燈線 H.D.D LED 灯线
					

## ACCESSORY KIT

配件包

		3.5" HDD screws / 3.5" HDD 螺絲 / 3.5" HDD 螺絲	X 8
		Motherboard screws and 2.5" SSD screws 主機板螺絲 / 2.5" SSD 螺絲 / 主机板螺絲 / 2.5" SSD 螺絲	X 17
		Power supply screws 電源螺絲 / 电源螺絲	X 7
		Stand off for motherboard and VGA riser cable 主機板銅柱 / 垂直顯卡排線銅柱 / 主机板銅柱 / 垂直顯卡排线铜柱	X 5
		3.5" HDD cage screws 3.5" HDD 硬碟槽手動螺絲 / 3.5" HDD 硬盘槽手动螺絲	X 1
		Cable ties 束線帶 / 束线带	X 6
		Fan splitter cable 小3 pin 風扇轉接線 / 小3 pin 风扇转接线	X 1

## REMOVING PANELS

前面板與左右側板拆卸說明 / 前面板与左右侧板拆卸说明

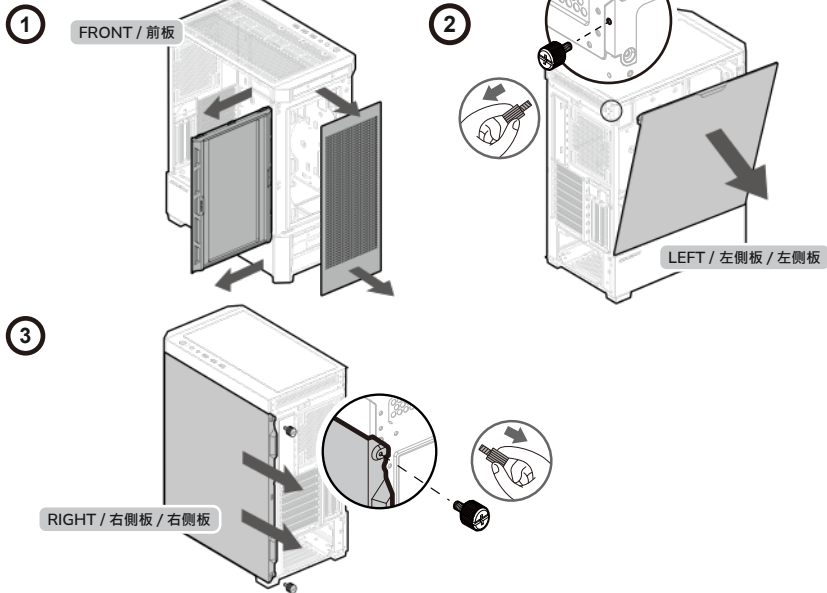

## INSTALLING WATER COOLING RADIATORS & COOLING FANS

水冷與風扇安裝說明 / 水冷与风扇安装说明

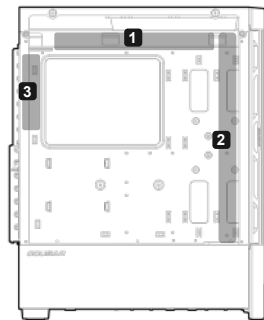

**1** ( Top / 上蓋 / 上蓋 )



**2** ( Front / 前板 )

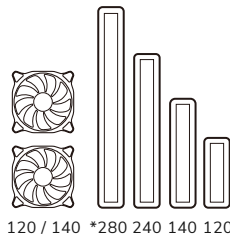

**3** ( Rear / 背板 )

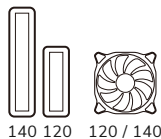

- Please choose either front or top to install a 280mm radiator.
- 280 mm 水冷排請擇一安裝於前板或上蓋。
- 280 mm 水冷排請擇一安裝於前板或上蓋。

## INSTALLING THE 3.5" HDDS

3.5" HDD 安裝說明 / 3.5" HDD 安裝說明

### 3.5" HDDS

RIGHT / 右側 / 右側

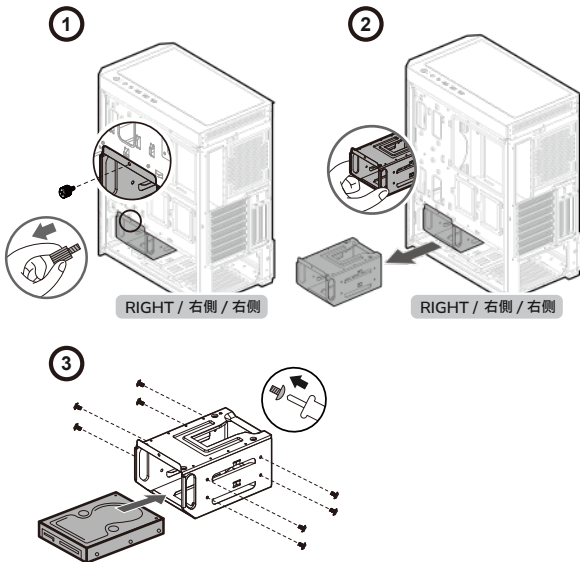
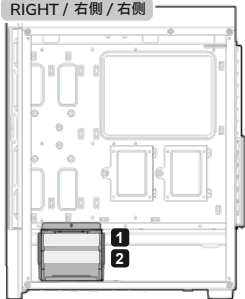

## INSTALLING THE 2.5" SSDS

2.5" SSD 安裝說明 / 2.5" SSD 安裝說明

### 2.5" SSDS

RIGHT / 右側 / 右側

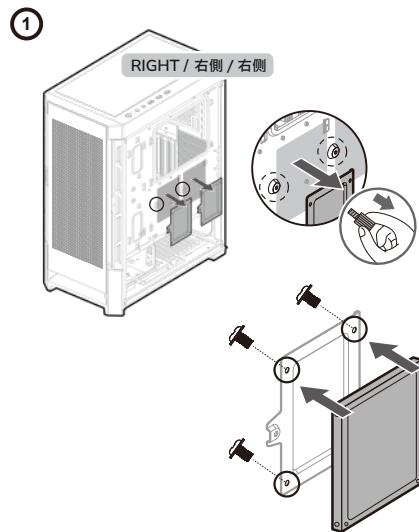
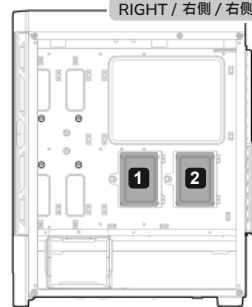

# CONTROLLING LIGHTING MODES

## RGB燈效操作說明 / RGB灯效操作说明

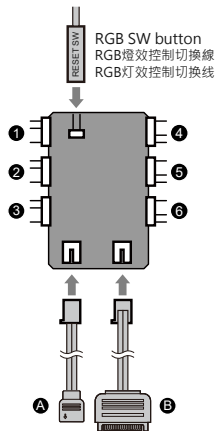

### FIRST MODE: SEVERAL LIGHTING EFFECTS

#### 模式一：多種預設燈效 / 模式一：多种预设灯效

- You can use the top panel's RGB button to switch between several beautiful lighting effects we have preset for you.
- 請短按上蓋的RGB燈效控制鍵，即可切換多種預設燈效。
- 請短按上蓋的RGB燈效控制鍵，即可切換多種預設灯效。

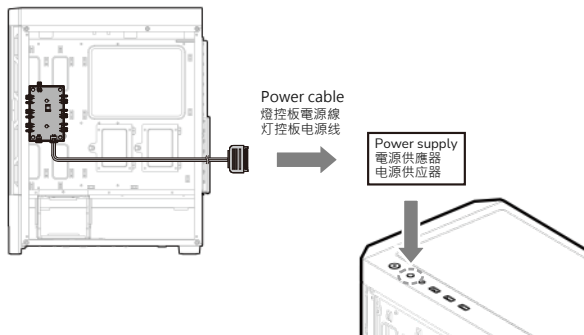

- A 5V Addressable RGB adapter  
5V/3pin ARGB 可編程主機板接頭 / 可编程主机板接头
- B Power connector  
燈控板電源線 / 灯控板电源线

- 1 4  
2 5  
3 6
- 5V Addressable RGB connector  
5V/3pin ARGB 可編程主機板接口 / 可编程主机板接口

# SECOND MODE: MOTHERBOARD SYNCHRONIZATION

## 模式二：主機板同步燈效 / 主机板同步灯效

Please use the included adapter to connect to a compatible motherboard's 3-pin 5V Addressable RGB header. Then, press and hold the RGB SW button for 3 seconds. The lights will flash in white once, it means the light signal has been changed to motherboard synchronization mode.

請使用燈控板隨附的5V/3pin ARGB可編程主機板接頭，連接至主機板上的5V/3pin接口，然後長按RGB燈效控制鍵3秒，會快閃白光一次，表示燈光訊號已切換至主板同步模式。

请使用灯控板随附的5V/3pin ARGB可编程主机板接头，连接至主机板上的5V/3pin接口，然后长按RGB灯效控制键3秒，会快闪白光一次，表示灯光讯号已切换至主板同步模式。

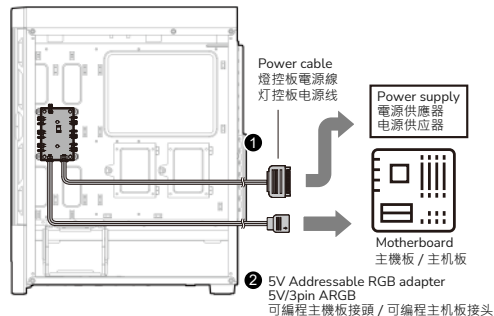

# SECOND MODE 模式二

## Motherboard synchronization 主機板同步燈效 / 主机板同步灯效

Press and hold the RGB button for 3 seconds.  
長按RGB燈效控制鍵3秒 / 长按RGB灯效控制键3秒



# BACK TO FIRST MODE

## 回復模式一 / 回复模式一

### Several Lighting Effects 多種預設燈效 / 多种预设灯效

Press the RGB button for one second.  
短按RGB燈效控制鍵1秒 / 短按RGB灯效控制键1秒



- If you press and hold the RGB button for 6 seconds, the lights will flash in white for twice, and the lights will be turned off.
- 如果長按RGB燈效控制鍵6秒，會快閃白光兩次，然後關閉燈效。
- 如果長按RGB燈效控制鍵6秒，會快閃白光兩次，然後關閉灯效。

- The lighting controller has memory function after REBOOTING. However, if you press and hold for 6 seconds and return on the light again, it will only return to the first light mode of default, and it cannot memorize the light effect before it was turned off.
- 電腦重新開機，可記憶關機之前的燈效。但如果透過長按RGB燈效控制鍵6秒的方式來關閉燈效，就沒有記憶功能，重新亮燈僅能回到模式一的初始預設燈效。
- 电脑重新开机，可记忆关机之前的灯效。但如果透过长按RGB灯效控制键6秒的方式来关闭灯效，就没有记忆功能，重新亮灯仅能回到模式一的初始预设灯效。





# INSTALLING GRAPHIC CARD

顯卡安裝說明 / 显卡安装说明

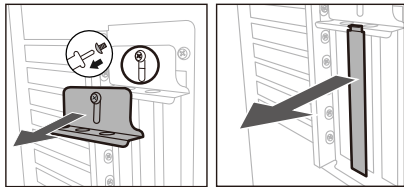
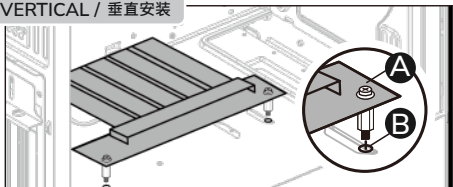
## VERTICAL / 垂直安裝



**A**   Motherboard screws and 2.5" SSD screws  
主機板螺絲 / 2.5" SSD螺絲  
主機板螺絲 / 2.5" SSD螺絲

**B**   Stand-off for VGA riser cable  
主機板銅柱 / 垂直顯卡排線銅柱  
主機板銅柱 / 垂直顯卡排線銅柱

 The vertical graphic card and the PCI-E riser cable are not included in the package, please purchase separately.  
顯卡和 PCI-E 轉接線不包含在包裝內，請單獨購買。  
顯卡和 PCI-E 轉接線不包含在包裝內，請單獨購買。

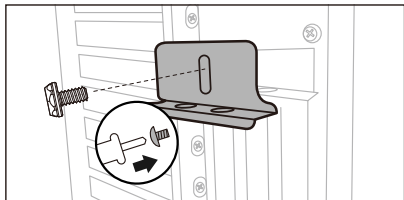
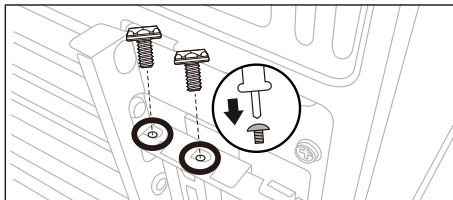
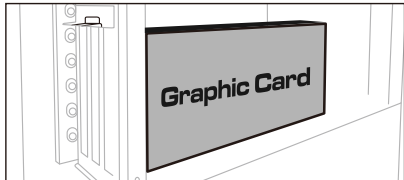

## HORIZONTAL / 水平安裝

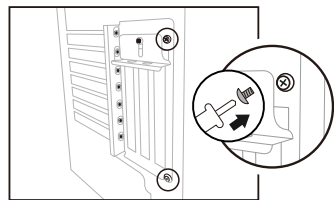
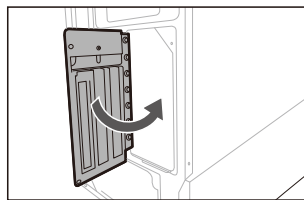
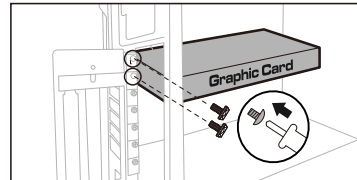
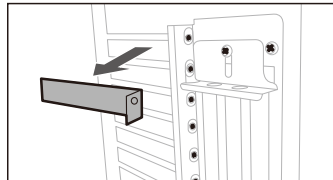
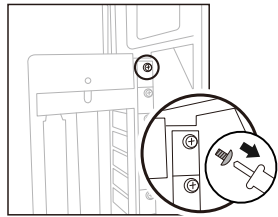
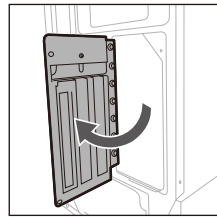
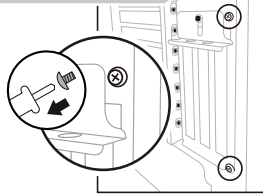

### ДАТА ИЗГОТОВЛЕНИЯ ПРОДУКЦИИ

год и месяц изготовления продукции указаны в серийном номере продукта.  
(существует 2 способа определения даты изготовления, оба способа описаны ниже)

**A** После S/N: первые две цифры означают год, вторые две – месяц изготовления.  
Например, S/N: H**2202**000001 означает, что товар был произведен в феврале 2022 года.

**B** После S/N: если указаны буквы, то две буквы представляют цифры из таблицы ниже, и означают год, последующие две цифры – месяц изготовления.  
Например, S/N: **DBV02**REVI000001 означает, что товар был произведен в феврале 2022 года.

A	B	C	D	E	F	G	H	I	J
1	2	3	4	5	6	7	8	9	0

• Например,  
BB = 22 = 2022 год

### تعليمات التركيب و الأمان:

• عند التركيب أو التفكيك يجب التأكد من أن جميع الأسلاك مفصولة عن الكهرباء.

• يجب اتخاذ الاحتراوات اللازمة لمنع الصعق الكهربائي.

• يجب إرتداء الملابس المناسبة أثناء تركيب/ تجميع الكمبيوتر.

• يجب تركيب كل قطعة بحذر و بمكانها المناسب.

• من يقوم بعلمية التركيب الشخص المختص فقط.

### БЪЛГАРИЯ

• Подробни инструкции за употреба изтеглете от: <https://cougargaming.com/bg>



България QR код

## GLOBAL WARRANTY POLICY

### 全球保固條款 / 全球保固條款

### WARRANTY PERIODS OF COUGAR GAMING DEVICES / COUGAR 電競產品保固期 / 电竞产品保固期

Product / 產品名稱 / 产品名称 : COUGAR AIRFACE RGB

Warranty / 保固期 : 1 Year / 1年

• This warranty gives you specific legal rights. You may also have other rights granted under local law. These rights may vary.

本保固條款賦予您特定的合法權利，而您所在的地區可能也會賦予您其他權利。  
本保固條款賦予您特定的合法權利，而您所在的地區可能也會賦予您其他權利。

• Only for electrical components.  
僅適用於電子元件 / 仅适用于电子元件。



详细保固条款  
请扫描二维码



Official website



COUGAR USA Technical Service  
Tel: (833) 256-3778  
Mail: rma@compucaseusa.com

Compucase Enterprise Co.,Ltd.  
All rights reserved.

CE Made in China